

STAINLESS STEEL - HARDWARE



Commodity grade Stainless Steel products in AISI 316, suitable for Marine, Architectural, Commercial and Industrial applications.

STAINLESS STEEL

D - Shackle - Screw Pin

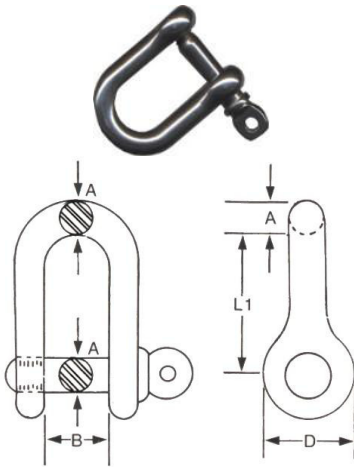

size (A) mm	B mm	D mm	L1 mm	Weight (Kg)	Breaking Load (kg)	CB CODE
4	8	8	16	0.011	750	36004
5	10	10	20	0.016	1 300	36005
6	12	12	24	0.024	1 800	36006
8	16	16	32	0.056	3 500	36008
10	20	20	40	0.130	5 400	36010
12	24	24	48	0.195	7 200	36012
14	28	28	56	0.350	12 000	36014

Bow Shackle - Screw Pin

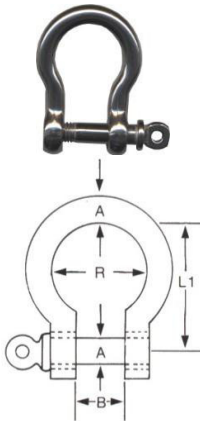

size (A) mm	B mm	R mm	D mm	L1 mm	Weight (Kg)	Breaking Load (kg)	CB CODE
4	8	14	8	16	0.012	750	37004
5	10	17	10	20	0.017	1 300	37005
6	12	21	12	24	0.028	1 800	37006
8	16	28	16	32	0.062	3 500	37008
10	20	34	20	40	0.150	5 400	37010

Long D Shackle - Screw Pin

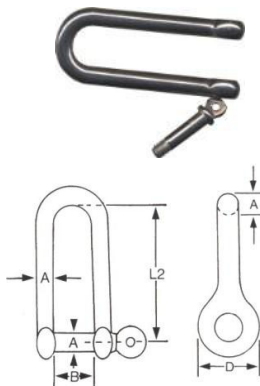

size (A) mm	B mm	D mm	L1 mm	Weight (Kg)	Breaking Load (kg)	CB CODE
4	8	8	32	0.014	800	36204
6	12	12	48	0.034	1 600	36206
8	16	16	64	0.082	3 200	36208
10	20	20	80	0.158	4 900	36210

STAINLESS STEEL - HARDWARE

Quick Link

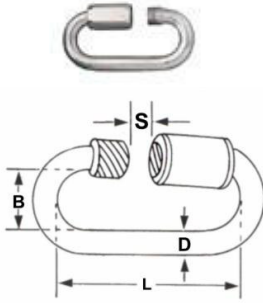

size (D) mm	L1 mm	B mm	S mm	Weight (Kg)	Breaking Load (kg)	CB CODE
4	32	12	5.5	0.88	700	735004
5	39	13	6.5	2.2	1 200	735005
6	45	14	7.5	3.8	1 600	735006
8	58	18	9.5	8	2 800	735008
10	69	22	12	14.4	4 200	73510

Spring Snap

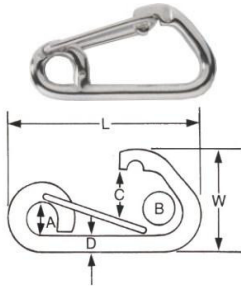

size mm	W mm	A mm	B mm	D mm	L mm	C mm	Weight (Kg)	Breaking Load (kg)	CB CODE
6	35	7	10	6	61	10	0.029	600	24306
8	48	11	13	8	81	13	0.075	1 600	24308
10	58	13	15	10	102	15	0.140	2 500	24310
12	70	16	21	12	122	21	0.234	3 500	24312

Spring Snap Hook (Double Locking)

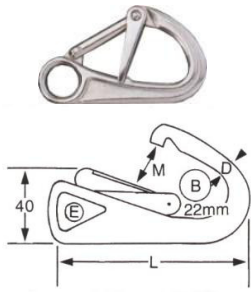

size mm	B mm	D mm	E mm	M mm	L mm	Weight (Kg)	Breaking Load (kg)	CB CODE
10	22	10	22	19	110	0.0172	1 400	2432

Carbine Hook with Eyelet

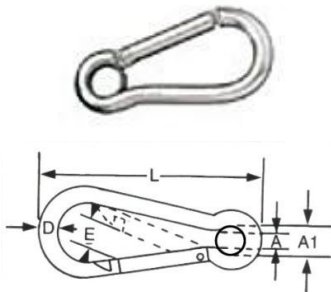

size (D) mm	L mm	A1 mm	A mm	E mm	B mm	Weight (Kg)	Breaking Load (kg)	CB CODE
5	50	10	6	8	7.5	2	570	245005
6	60	13	8	9	9	2.9	670	245006
8	80	13	8	9	11.5	6.5	870	245008
10	100	16	10	12	14	12.9	1 150	245010
11	120	18	11	16	16.5	16.8	1 250	245011
12	140	20	13	19	18	24	1 280	245012

Carbine Hook with Eyelet and Lock Nut

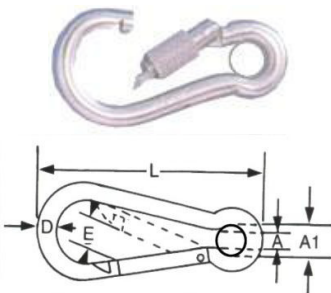

size (D) mm	L mm	A1 mm	A mm	E mm	B mm	Weight (Kg)	Breaking Load (kg)	CB CODE
6	60	13	8	9	9	2.9	670	8501201
8	80	13	8	9	11.5	6.5	870	8501501
10	100	16	10	12	14	12.9	1 150	8501502

STAINLESS STEEL- HARDWARE

Carbine Hook with Eyelet and Safety Catch

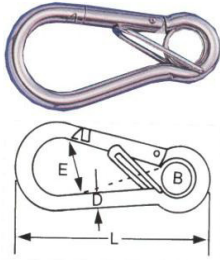

size (D) mm	L mm	A1 mm	A mm	E mm	B mm	Weight (Kg)	Breaking Load (kg)	CB CODE
6	60	13	8	9	9	2.9	670	2450106
8	80	13	8	9	11.5	6.5	870	2450108
10	100	16	10	12	14	12.9	1 150	2450110

Spring Snap

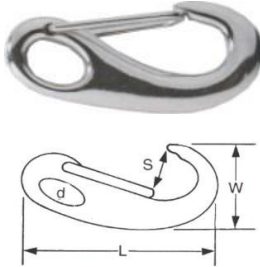

size L mm	W mm	S mm	d mm	Weight (g)	Working Load (kg)	CB CODE
50	25	10	8	20	70	247050
70	31	11	12	50	150	247070
100	50	15	16	150	300	247100

Swivel Snap Shackle



size	A mm	B mm	L mm	Weight (g)	Breaking Load (kg)	CB CODE
1	12	12	70	0.060	1 800	24821
2	16	16	87	0.125	2 800	24822
3	22	22	128	0.315	3 800	24823

Fixed Snap Shackle



size	A mm	B mm	L mm	Weight (g)	Breaking Load (kg)	CB CODE
1	12	9	52	0.042	1 800	24831
2	16	12	66	0.090	2 800	24832
3	22	16	96	.0235	3 800	24833



Swivel Eye Bolt Snap	size ID mm	CB CODE
	9.5	55005
	16	55007
	25	55009



Fixed Eye Bolt Snap	size ID mm	CB CODE
	53	24953
	73	24973
	81	24981

STAINLESS STEEL- HARDWARE

Eye Nuts

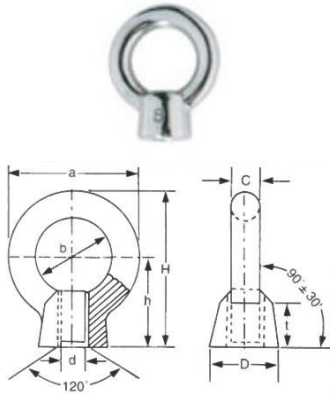

size	a mm	b mm	c mm	D mm	H mm	Safe Vertical Working Load (kg/t)	CB CODE
M6	26	16	5	13	28.3		306106
M8	32.6	20	6.3	16	33.3	80	306108
M10	41	25	8	20	41.5	150	306110
M12	50	30	10	25	51	220	306112
M16	60	35	12.5	30	60	450	306116

Long Eye Bolt

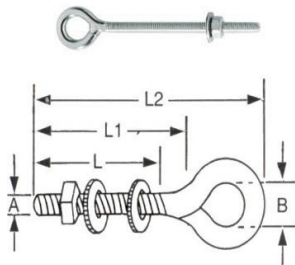

size A mm	B mm	L mm	L1 mm	L2 mm	CB CODE
6	13	34	40	60	31910606
6	13	74	80	100	31910610
8	17	72	80	110	31910811
10	21	90	100	150	31911015

Long U-Bolt

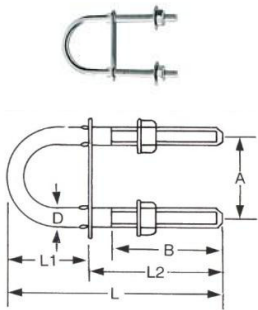

size	A mm	B mm	L mm	L1 mm	CB CODE
M4	30	30	64	27	413460
M5	35	40	80	35	413580
M6	35	40	90	35	413690
M8	35	40	80	35	413880
M8	35	40	100	40	41388100
M10	50	55	130	55	413113
M12	60	65	150	65	41312150

Diamond Eye Plate

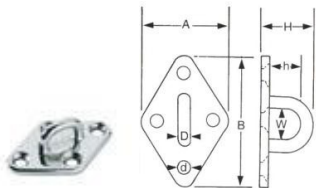

size	D mm	A mm	B mm	H mm	h mm	W mm	CB CODE
6	6	40	64	26	15	15	321106
8	8	50	80	33	20	18	321108

Eye Strap

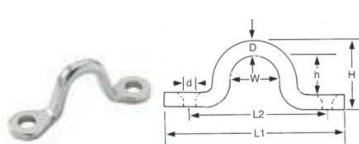

size mm	D mm	L1 mm	L2 mm	H mm	h mm	W mm	d mm	CB CODE
4	4	40	32	16	11	10	3.2	32204
5	5	51	40	16	13	11	4.2	32205
6	6	57	44	22	16	14	5.2	32206

STAINLESS STEEL- HARDWARE

"D" Ring

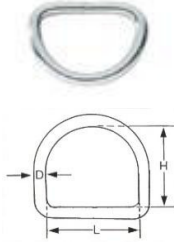

size	d mm	L mm	H mm	CB CODE
4	4	30	27	3250430
5	5	47	50	3250550
6	6	37	40	3250640
6	6	47	50	3250650

Round Ring

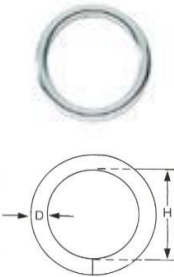

D mm	H mm	CB CODE
4	30	31704030
5	40	31705040
6	40	31706040
6	45	31706045
6	60	31706060
8	50	31708050

Turnbuckles - Frame type



H+E

Type	Thread Dia mm	CB CODE
Hook and Eye		3011-04/05/06/08/10/12

Wire Rope Clamp (Crosby Clamp)



Thread Dia mm	CB CODE
3, 4, 5, 6, 8, 10, 12	2600-3/4/5/6/8/10/12

Wire Thimble



Thread Dia mm	CB CODE
2, 3, 4, 5, 6, 8, 10, 12, 14, 16, 18, 20	11000-2/4/5/6/8 1100-10/12/14/16/18/20

Copper Ferrule (Nickel-Plated)



Thread Dia mm	CB CODE
1.5, 2, 2.5, 3, 4, 5, 6	31-69/70/71/72/73/74/75